

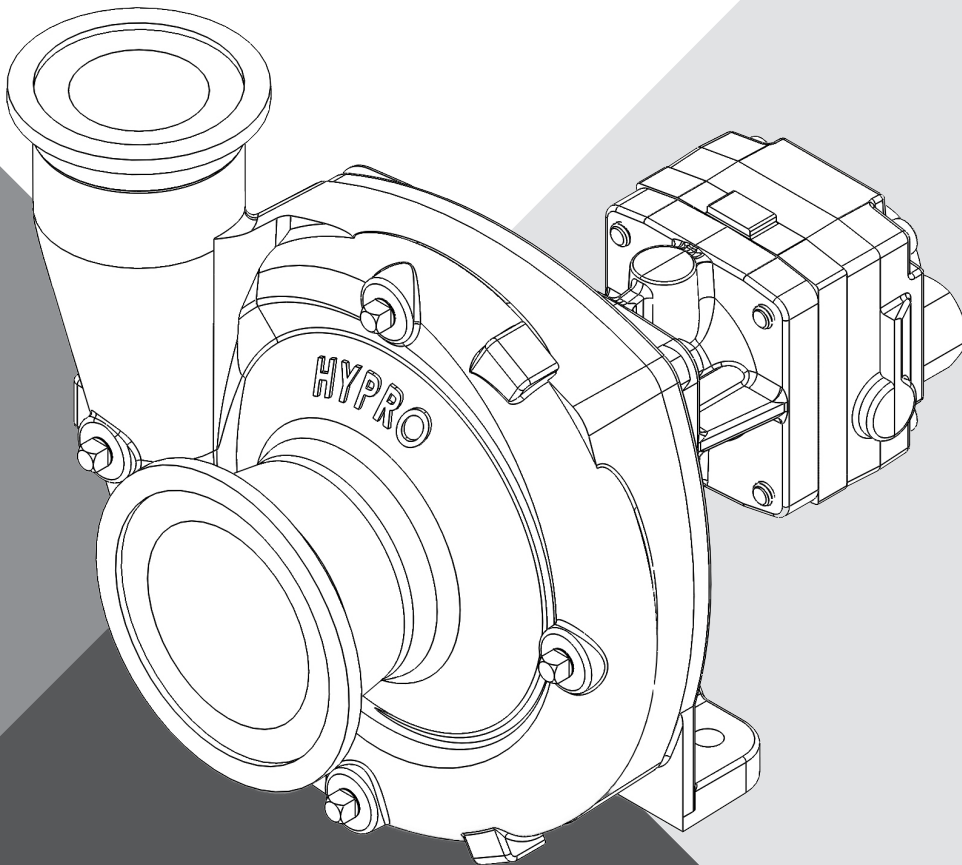

KEEP FOR FUTURE REFERENCE

CAST IRON SERIES CENTRIFUGAL PUMPS

9306C ♦ 9306S



INSTALLATION AND OPERATION MANUAL

pentair.com

EU Authorized Representative:
EC REP QNET BV Hommerweg 286
6436 AM Amstenrade, The Netherlands
KvK Zuid-Limburg 14091511

Pentair
375 5th Ave. NW, New Brighton, MN 55112
Phone: (651) 766-6300 -OR- 800-424-9776
Fax: 800-323-6496
www.pentair.com

L-1596 Rev. B (12-09-19)

Contents

EU Language Manuals.....	3
Introduction.....	4
Description.....	4
Intended Uses.....	4
Purpose of Manual.....	4
Misuses.....	5
Pump Identification.....	5
Pump Technical Data.....	6
Fluid Pumping Applications.....	10
Tools.....	10
Lifting, Transport, and Intermediate Storage.....	10
Assembly and Installation.....	11
Assembly.....	11
Installation.....	11
Plumbing Diagram.....	12
Control Systems.....	13
Commissioning Start-Up, Operation, Shutdown.....	14
Information.....	14
Start-Up, Operation, Shutdown.....	14
Maintenance and Servicing.....	16
Information.....	16
Disposal.....	16
Cleaning.....	16
Maintenance, Routine Servicing, and Inspection.....	17
Troubleshooting.....	17
Replacement Parts.....	18
Declaration of Incorporation.....	19
Warranty.....	Last page

EU Language Manuals

DO NOT attempt to install or operate your pump before reading the manual. Original copies of the manual for Hypro pumps are provided in English. To find a copy in your native language, go to www.hypro.pentair.com.

Vor dem Ablezen des Handbuches versuchen Sie NICHT, Ihre Pumpe zu installieren. Originale des Handbuches für Hypro-Pumpen werden auf englisch zur Verfügung gestellt. Zu eine Kopie in Ihrer Muttersprache finden, zu www.hypro.pentair.com zu gehen (German)

N'essayez pas d'installer votre pompe avant de lire le manuel. Des exemplaires originaux du manuel pour des pompes de Hypro sont fournis en anglais. Pour trouver une copie dans votre langue maternelle pour aller a www.hypro.pentair.com (French)

NON tentare di installare la vostra pompa prima di leggere il manuale. Esemplare originale del manuale per Hypro pompe sono in inglese. Per trovare una copia nella vostra lingua andare a www.hypro.pentair.com (Italian)

Не пытайтесь установить ваш насос до чтения руководства. Оригинальные копии этого руководства для насосы Hypro на английском языке. Найти копию на ваш родной язык перейти к www.hypro.pentair.com (Russian)

NO intente instalar su bomba antes de leer el manual. Copias originales del manual para Hypro se provee de bombas en ingles. Para encontrar una copia en tu idioma nativo ir a www.hypro.pentair.com (Spanish)

NIE próbować instalować pompy przed jej odczytaniem instrukcji. Oryginalne kopie instrukcji obsługi pomp Hypro są dostarczane w języku angielskim. Aby uzyskać kopię w twoim ojczystym języku przejdź do www.hypro.pentair.com (Polish)

Takmaya çalışmayın okumadan önce pompanın manuel. Orijinal kopyalarını Hypro pompaları için İngilizce olarak sunulmuştur. Bir kopyasını bulmak için yerel dil git www.hypro.pentair.com (Turkish)

Nao tente instalar a bomba antes de ler o manual. As copias originais dos manuais para Hypro bombas sao fornecidos em Ingles. Para encontrar uma copia em sua lingua nativa ir para www.hypro.pentair.com (Portuguese)

VERGEET NIET uw pomp voor het lezen van het handboek. Exemplaren van de handleiding voor Hypro pompen zijn beschikbaar in het Engels. Op zoek naar een exemplaar in uw eigen taal ga naar www.hypro.pentair.com (Dutch)

Introduction

Description

Hypro centrifugal pumps are designed for creating and boosting pressure in fluid circuits. The pump operates by taking in fluid from the inlet port after which it is slung by the impeller and expelled through the outlet port. Construction features include housings, impellers and seals which come in a variety of materials in order to be resistant to a range of chemicals. Standard models of centrifugal pumps rotate clockwise, when looking at the front (Volute end) of the pump.

Intended Uses

Hypro centrifugal pumps are intended for creating or boosting dynamic pressure in approved fluids. Hypro centrifugal pumps should never be used to pump liquids above 140°F (60°C), or below 34°F (1°C). For pumps equipped with hydraulic motors, the pump should not be run if the hydraulic oil temperature exceeds 160°F (71°C). Any uses outside of those specified in this manual are considered misuses and are prohibited. Contact Hypro technical service with any questions regarding specific acceptable uses.

Purpose of Manual

Hypro has provided this manual to provide instructions and requirements that must be met when installing, using and maintaining the product(s) included in this document.

If the product is sold, the seller must pass this manual onto the new owner.

The following special attention notices are used to notify and advise, the user of this product, of procedures that may be dangerous to the user or result in damage to the product.

ATTENTION

Attention is used to notify of installation, operation, or maintenance information that is important but not safety related.



This symbol is used to denote the presence of an electrical hazard that will result in personal injury, death or property damage.



This symbol is used to denote the presence of a hazard that will result in personal injury, death or property damage.

California Proposition 65 Warning -- This product and related accessories contain chemicals known to the State of California to cause cancer, birth defects or other reproductive harm.

Misuses

Hypro centrifugal pumps are designed to operate effectively within the specified speed, pressure and environmental ranges. Going outside of these ranges will void the warranty and could cause damage to property, serious injury, or death.

- **DO NOT** run the pump faster than the maximum specified speed.
- **DO NOT** run the pump higher than the maximum specified pressure.
- **DO NOT** run pumps when the liquid has exceeded the maximum or minimum temperature limit (see Intended Uses).
- **DO NOT** pump non-approved liquids.
- **DO NOT** pump water or other liquids for human consumption.
- **DO NOT** operate any Hypro pump under the influence of drugs or alcohol.
- **DO NOT** run the pump dry.
- **DO NOT** run the pump with a higher than recommended voltage.
- **DO NOT** run the pump hydraulic motor higher than the specified RPM, pressure or flow.
- **DO NOT** use pumps in an explosive environment.
- **DO NOT** attach a pipe, hose or fitting to the pump that is not rated for the maximum pressure of the pump (outlet) or vacuum of the pump (inlet).
- **DO NOT** run the pump in reverse of its intended rotation.
- **DO NOT** operate a pump with a gasoline engine in an enclosed area.

Pump Identification

Hypro uses serialized labeling to enable users to precisely identify the pump's manufacturing date.

Serial Number:

First and second digits: year (14 = 2014)

Third through fifth digits: consecutive day of the year the pump was manufactured.

Sixth through tenth digits: unique pump serial number.

Pump Technical Data

(All specifications and performance data are based on water as a carrier fluid.)

9306C(S)-HM1C, -HM3C, and -HM5C

Pump Dimensions			
	Dim.	Inch	mm
HM1,3,5	A	9.08	230.6
	B	9.34	237.2
	C	5.19	131.8
	D	4.33	110.0
	E	3.88	96.8
HM1	F	11.47	291.3
HM3	F	11.97	304.0
HM5	F	11.59	294.4
HM1,3,5	G	5.03	127.8
	H	5.25	133.4
	I	2.63	66.8
	J	1.60	40.6
	K	3.81	96.8

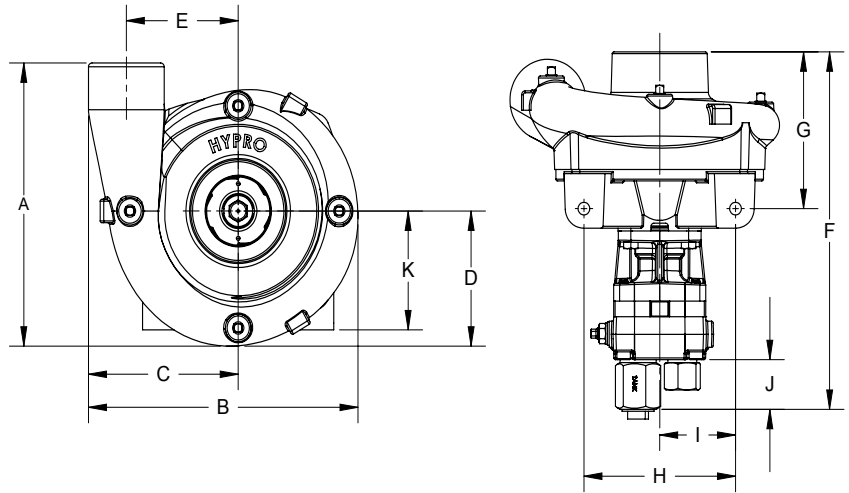

9306C(S)-HM1C-3U, -HM3C-3U, and -HM5C-3U

Pump Dimensions			
	Dim.	Inch	mm
HM1,3,5	A	9.45	240.1
	B	9.66	245.1
	C	5.51	140.0
	D	4.33	110.1
	E	3.88	96.8
HM1	F	12.33	313.1
HM3	F	12.83	325.9
HM5	F	12.45	316.2
HM1,3,5	G	5.89	149.6
	H	5.25	133.4
	I	2.63	66.8
	J	1.60	40.6
	K	3.81	96.8

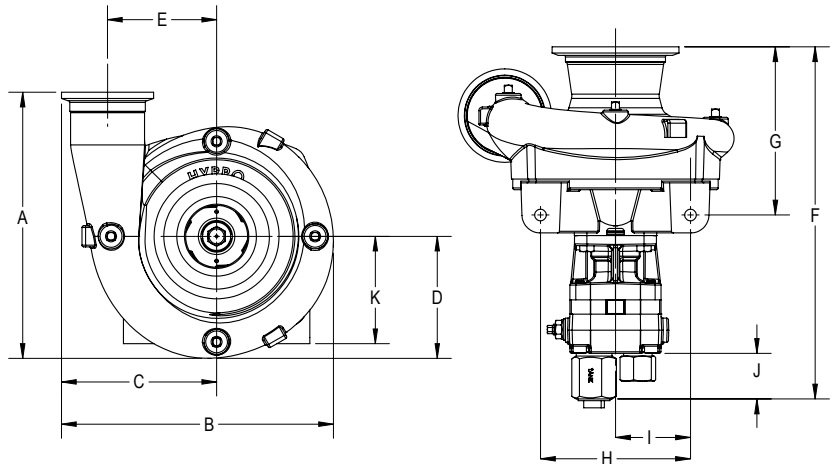

9306C(S)-HM1C-U, -HM3C-U, and -HM5C-U

Pump Dimensions			
	Dim.	Inch	mm
HM1,3,5	A	9.45	240.0
	B	9.66	245.4
	C	5.51	140.0
	D	4.33	110.0
	E	3.88	96.8
HM1	F	12.64	321.1
HM3	F	13.14	333.8
HM5	F	12.76	324.1
HM1,3,5	G	6.20	157.5
	H	5.25	133.4
	I	2.63	66.8
	J	1.60	40.6
	K	3.81	96.8

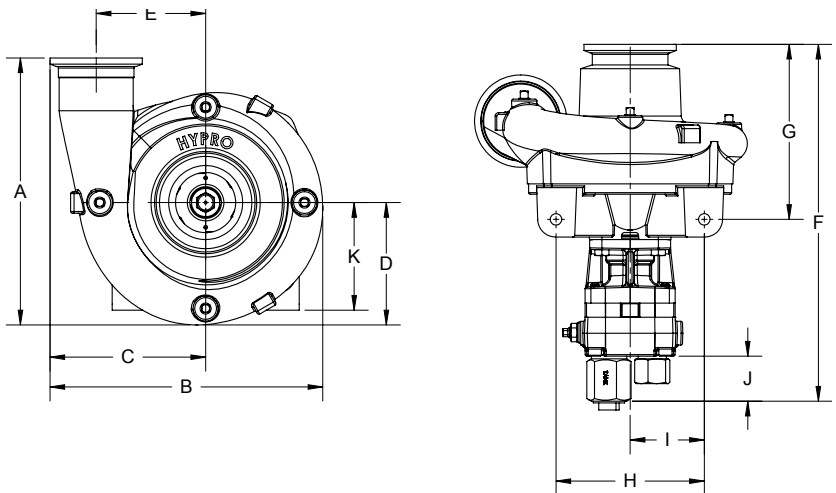

Pump Technical Data

9306C-HM1C, 9306S-HM1C, 9306C-HM3C, 9306S-HM3C, 9306C-HM5C, 9306S-HM5C Pump Specifications

Pump	Hydraulic Max PSI [BAR]	Hydraulic Max Outlet (PSI) [BAR]	Max Flow Rate (GPM) [LPM]	Max Pressure (PSI) [BAR]	Max Hyd Flow (GPM) [LPM]	Ports	Hydraulic Ports	Dry Weight lb[kg]	Mounting Bolts
9306C-HM1C	3000 [206.84]	100 [6.9]	207 [784]	127 [8.8]	13 [49.2]	2" NPT Inlet 1-1/2"NPT outlet	1/2" NPT Inlet, 3/4" NPT Outlet, SAE -4 Case Drain (if equipped)	34 [15.4]	2X 3/8" OR M10
9306S-HM1C								32.8 [14.9]	
9306C-HM3C			214 [810]	128 [8.8]	24 [90.8]			35.4 [16.1]	
9306S-HM3C								38 [17.2]	
9306C-HM5C			212 [803]	140 [9.7]	17 [64.4]			34.2 [15.5]	
9306S-HM5C								35 [15.9]	

9306C-HM1C-3U, 9306S-HM1C-3U, 9306C-HM3C-3U, 9306S-HM3C-3U, 9306C-HM5C-3U, 9306S-HM5C-3U Pump Specifications

Pump	Hydraulic Max PSI [BAR]	Hydraulic Max Outlet (PSI) [BAR]	Max Flow Rate (GPM) [LPM]	Max Pressure (PSI) [BAR]	Max Hyd Flow (GPM) [LPM]	Ports	Hydraulic Ports	Dry Weight lb[kg]	Mounting Bolts
9306C-HM1C-3U	3000 [206.84]	100 [6.9]	283 [1071]	127 [8.8]	13 [49.2]	3" Universal Flange Inlet 2" Universal Flange Outlet	1/2" NPT Inlet, 3/4" NPT Outlet, SAE -4 Case Drain (if equipped)	35.3 [16.0]	2X 3/8" OR M10
9306S-HM1C-3U								35 [15.9]	
9306C-HM3C-3U			322 [1219]	128 [8.8]	24 [90.8]			36.2 [16.4]	
9306S-HM3C-3U								38 [17.2]	
9306C-HM5C-3U			312 [1181]	140 [9.7]	17 [64.4]			35.1 [15.9]	
9306S-HM5C-3U								36.5 [16.6]	

9306C-HM1C-U, 9306S-HM1C-U, 9306C-HM3C-U, 9306S-HM3C-U, 9306C-HM5C-U, 9306S-HM5C-U Pump Specifications

Pump	Hydraulic Max PSI [BAR]	Hydraulic Max Outlet (PSI) [BAR]	Max Flow Rate (GPM) [LPM]	Max Pressure (PSI) [BAR]	Max Hyd Flow (GPM) [LPM]	Ports	Hydraulic Ports	Dry Weight lb[kg]	Mounting Bolts
9306C-HM1C-U	3000 [206.84]	100 [6.9]	207 [783]	127 [8.8]	13 [49.2]	2" Universal Flange Inlet 2" Universal Flange Outlet	1/2" NPT Inlet, 3/4" NPT Outlet, SAE -4 Case Drain (if equipped)	36 [16.3]	2X 3/8" OR M10
9306S-HM1C-U								33 [15.0]	
9306C-HM3C-U			214 [810]	128 [8.8]	24 [90.8]			37.5 [17.0]	
9306S-HM3C-U								39.5 [17.9]	
9306C-HM5C-U			212 [803]	140 [9.7]	17 [64.4]			35.6 [16.2]	
9306S-HM5C-U								35 [15.9]	

Pump Technical Data

**9306C-HM1C & 9306S-HM1C
9306C-HM1C-U & 9306S-HM1C-U**

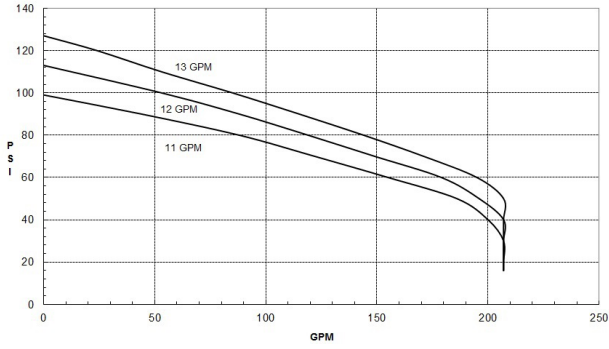

**9306C-HM1C & 9306S-HM1C METRIC
9306C-HM1C-U & 9306S-HM1C-U**

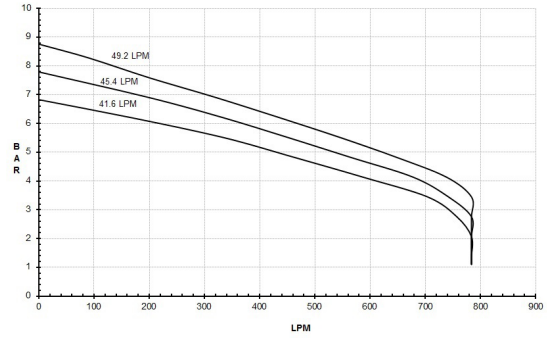

**9306C-HM3C & 9306S-HM3C
9306C-HM3C-U & 9306S-HM3C-U**

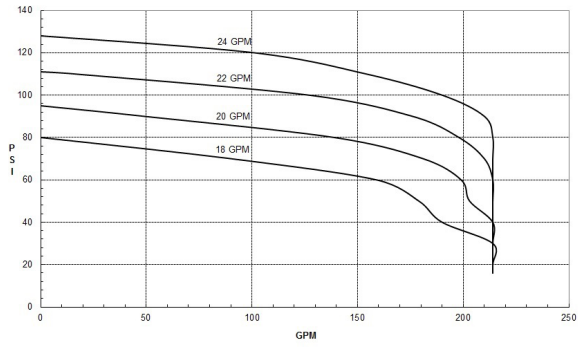

**9306C-HM3C & 9306S-HM3C METRIC
9306C-HM3C-U & 9306S-HM3C-U**

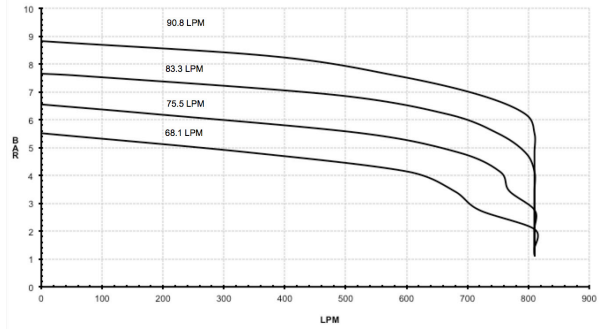

**9306C-HM5C & 9306S-HM5C
9306C-HM5C-U & 9306S-HM5C-U**

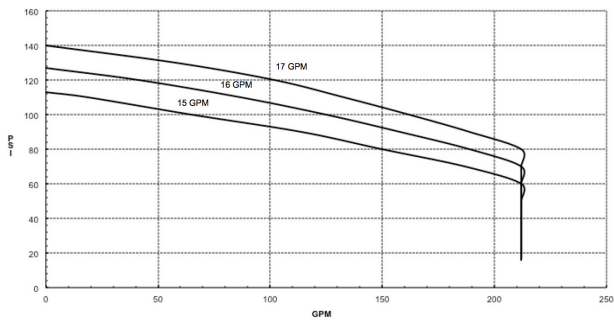

**9306C-HM5C & 9306S-HM5C METRIC
9306C-HM5C-U & 9306S-HM5C-U**

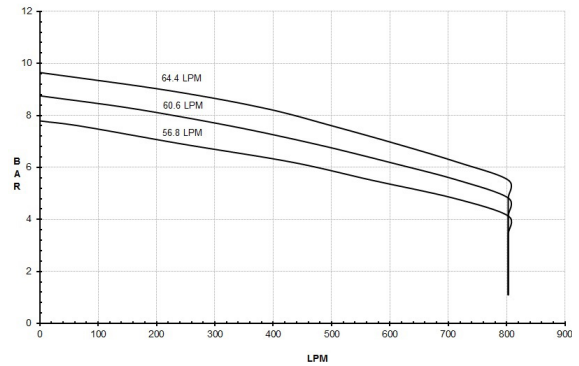

Pump Technical Data

9306C-HM1C-3U & 9306S-HM1C-3U

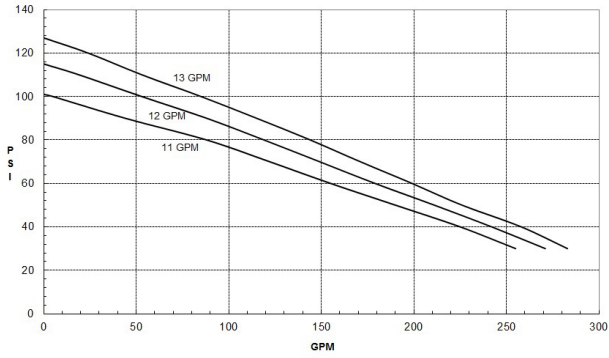

9306C-HM1C-3U & 9306S-HM1C-3U METRIC

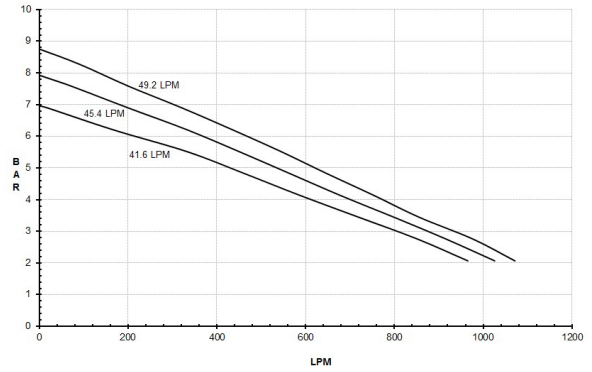

9306C-HM3C-3U & 9306S-HM3C-3U

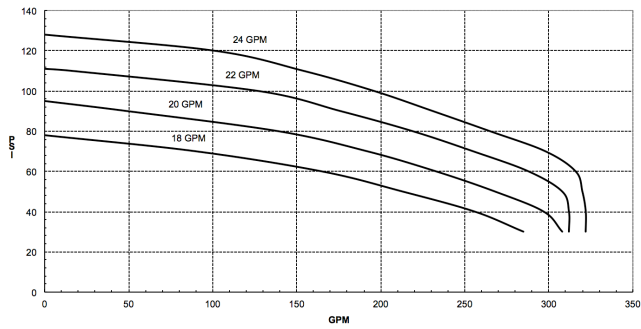

9306C-HM3C-3U & 9306S-HM3C-3U METRIC

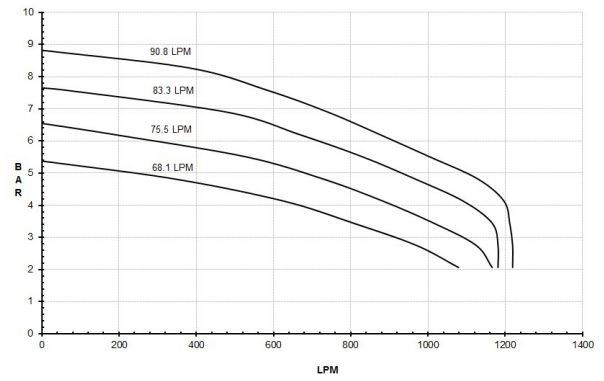

9306C-HM5C-3U & 9306S-HM5C-3U

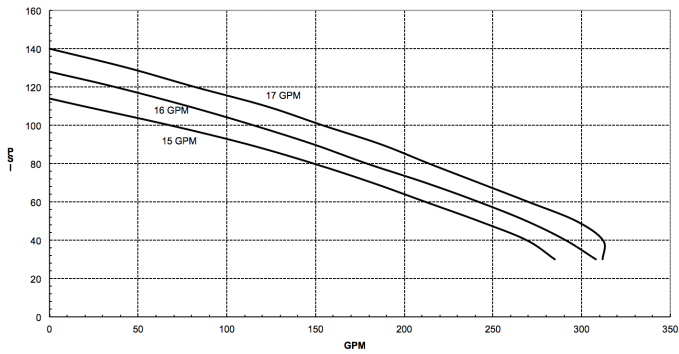

9306C-HM5C-3U & 9306S-HM5C-3U METRIC

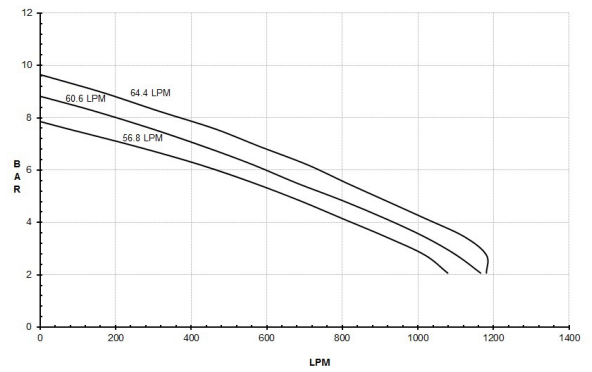

Fluid Pumping Applications

Application	Pump Materials Compatibility						
	Impeller			Pump Housing		Seal	
	Nylon	Polypropylene	GTX	Stainless	Cast Iron	Ceramic	Silicon Carbide
Weed Control Chemicals	X	X	X	X	X	X	X
Insect Control	X	X	X	X	X	X	X
Brush Control	X	X	X	X	X	X	X
Pest Control Chemicals and Fumigants	X	X	X	X	X	X	X
Liquid Fertilizers	X	X	X	X		X	X
Powdered Fertilizers	X	X	X	X	X	X	X
Fluid Transfer	X	X	X	X	X	X	X
Acids		X					X

Table 1

Flammable liquids, sewage, and clean water should never be pumped through a Hypro pump. Hypro pumps are not designed to be used as clean water pumps as defined in 10CFR Parts 429 and 431.

Tools

The Hypro centrifugal pumps and mounting assemblies are designed with Imperial (inch) bolts, however, there are many metric (mm) sizes which will work with these mounts. In most cases, an adjustable spanner wrench can also be used.

Lifting, Transport, and Intermediate Storage

Packaging Descriptions and Unpacking Instructions

- Hypro centrifugal pumps are shipped in cardboard boxes for safe transporting.
- When pumps are shipped in large quantities, they may be put on a pallet to allow for easy storage, lifting and handling.
- Before lifting any pump or pallet, determine the weight of the item by looking at the attached packing slips to establish what lifting equipment should be used.
- Before installing the pump, determine if all the components are present and undamaged. If the pump is missing components, contact customer service immediately.
- Once the pump is unpacked, dispose of the packaging in a manner compliant with local and national regulations.

Lifting Instructions

- Before attempting to lift a Hypro pump, ensure that the surrounding working area is free of hazards which could cause injury or damage to property.
- During lifting operations, any personnel not involved in the lift should not enter the working area.
- If lifting hooks, rope or chains are being used for a lift, they must be free of damage and be rated to carry 150% of the weight of the load to be lifted.
-  Always wear steel-toed shoes and cut-resistant gloves when attempting to lift.
- When lifting and carrying, always keep the pump close to your body. (See Figure 1)
- When starting the lift, bend your knees and keep your back straight. (See Figure 1) Tightening the stomach muscles will help keep your back straight.
- During the lift, use your legs to do the work. Never use your back, and make sure your legs are at least shoulder-width apart. (See Figure 1)

Figure 1



Transport

- All Hypro pumps are capable of being transported by air, sea, rail or motor vehicle. When the pump is shipped, ensure that the pump is moved in accordance with local and national laws and is properly secured to prevent unwanted movement which could cause damage to person or property. Prior to shipping, all fluids should be removed from the pump.

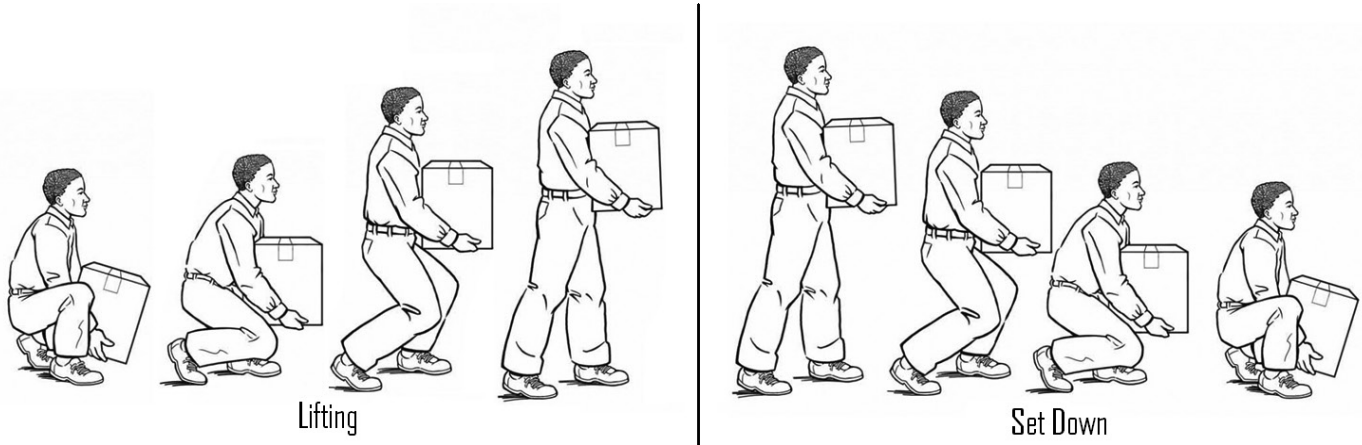
Storage

- New pumps in their boxes can be stored several years as long as the port plugs are not removed. Once the plugs have been removed, if the pump is not to be used for an extended period of time (i.e. more than 30 days), the pump must be winterized as described in the Cleaning section of this manual.

Assembly and Installation

Assembly

- This pump comes completely assembled.

Installation

Before attempting to install your Hypro centrifugal pump, it is imperative to read and understand the following:

- ⚠ Installation of a Hypro pump should only be performed by a technician having the knowledge and skills necessary to install the pump without the risk of property damage or injury.
- ⚠ When handling Hypro pumps, one should wear steel-toed shoes and protective gloves in order to protect the feet in the event the pump is dropped and protect the hands from any sharp surfaces on the pump or chemicals.
- ⚠ Pumping systems must be installed in accordance with Hypro installation instructions. Failure to do so will void your warranty and could cause damage to property, serious personal injury, or death
- ⚠ Electrical power cables and pump hoses must be routed where there is no risk of personnel tripping, walking into, or falling because they have been routed in areas where personnel are expected to move. Electrical power cables and pump hoses should be routed according to local and national standards.
- ⚡ It is the installer's responsibility to ensure that AC electric-drive motors, Hypro pumps, and metalwork of support structures are bonded to earth (ground), per local and national standards.
- ⚡ It is the installer's responsibility to conduct earth continuity tests between AC electric-drive motors, Hypro pumps, and metalwork of support structures and earth according to EN60204-1:2006/A1:2009, or its superseding standard, to confirm that all components that need to be connected to earth are satisfactorily bonded.
- ⚡ It is the installer's responsibility to conduct electrical tests in accordance with EN60204-1:2006/A1:2009, or its superseding standard, on finished pump assemblies.
- All connections to electrical components must be number, symbol, or color-coded generally as recommended by EN60204-1:2006/A1:2009, or its superseding standard.

- **⚠** Installers must provide hydraulic components that are capable of withstanding maximum source pressure.
- **⚠** The working pressure must be controlled by a pressure relief valve that is adjusted to operate at a maximum pressure of the hydraulic motor.
- **⚠** For pumps with gas engines, the exhaust must be directed away from operators and anyone standing nearby to ensure that exhaust fumes do not enter their breathing zone.
- **⚠** If a rigid plumbing system is to be used on a Hypro centrifugal pump, the system must be properly aligned with the inlet and outlet ports.
- **⚠** The working pressure in the hydraulics system must be controlled by a pressure relief valve that is adjusted to operate at 10% of the maximum system pressure.
- **⚠** When installing, adjusting or removing a Hypro centrifugal pump, ensure that there are no objects which can fall on the installer and make certain that all machinery to which the pump is to be attached is turned off.
- **⚠** Pumps must be installed in a location where they are accessible for any necessary maintenance.
- **⚡** When a main electrical supply is needed to power electric-drive motors, installers are responsible for ensuring that a supply disconnect device, capable of isolating the machine from its electricity supply, be provided.
- **⚠** When hydraulic power is used, the system should contain a quick disconnect coupling that can be disconnected to isolate the pump.

Standard Mounting

- In order to prevent injury or damage to property, all Hypro pumps should be properly mounted to a solid base where there is no danger of the pump falling or breaking loose. All Hypro pumps come with mounting holes which allow bolts to be put into the pump so it can be secured to a sturdy base. When mounting your Hypro centrifugal pump, be sure to use bolts and nuts which are compatible with any chemicals that may come into contact with them as well as choosing the correct grade of bolt based on the pump weight and any expected loads. Pumps should be mounted as close to the liquid source as possible. Non self-priming pumps must be mounted below the liquid level to function properly.

Pump Plumbing

- To achieve maximum pump performance the outlet port on the pump should be pointing straight up, and pump inlet and outlet lines should be at least the same size as their respective port. Pump plumbing must be capable of withstanding the maximum suction, and pressure, generated by the pump and should have as few restrictions as possible.
- For best priming results, the upper most vent plug can be removed and a vent line can be installed. This line prevents air lock and allows the pump to prime itself by bleeding off trapped air. Avoid any dips or bends in the suction line plumbing that could trap air. Avoid any dips or bends in the suction line plumbing that could trap air.

Ref. No.	Description
1	Tank Lid
2	Vent Line
3	Jet Agitator
4	Shut-off Ball Valves
5	Centrifugal Pump
6	Spray Control Console
7	Centrifugal Pump Control
8	Manifold Boom Valve
9	Flowmeter
10	Jet Turret Nozzle Body

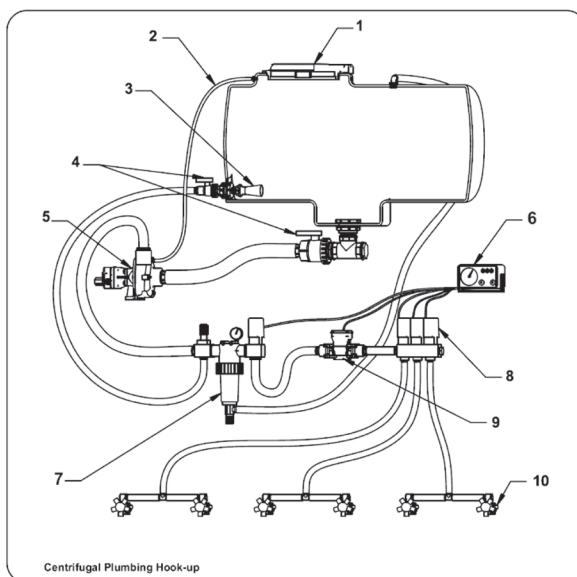

Hydraulic Installation

Prior to installation, refer to the tractor or sprayer manual and determine what type of hydraulic system is being used. The three types of systems include:

- Open center systems
- Closed center (Pressure-Compensated) systems
- Closed center Load Sensing (Flow and Pressure-Compensated) systems
- The hydraulic motor must be correctly configured and sized for the hydraulic system:
 - Open center systems
 - Excess oil from the hydraulic pump must be bypassed around the motor
 - Built in bypass option in motor endplate, or separate bypass valve installed in the line feeding the motor inlet.
 - Use the largest motor possible
 - Closed center (Pressure-Compensated) systems
 - Metering orifices needed for optimal performance
 - Use the smallest motor possible
 - Closed center Load Sensing (Flow and Pressure-Compensated) systems
 - No special requirement for bypass or metering orifices

Hydraulic system plumbing

- When installing the hydraulic motor into the tractor's or sprayer's hydraulic system, make sure that no dirt or liquid gets into the hydraulic motor.

KEEP ALL HYDRAULIC CONNECTIONS CLEAN.

- Ensure return line is connected to low pressure return port on the tractor recommended for hydraulic motors, the ports are identified on the motor casting. Hydraulic supply lines should be at least the same size as the hydraulic motor port or larger.
- Standard models come equipped with check valve port adapters which should not be removed.

Hooking up the motor in the wrong direction will damage the hydraulic seal.

- Hydraulic back pressure in the return line must be less than 100 PSI [6.9 bar] to prevent reduced seal life. Pressures under 50 PSI [3.4 bar] are recommended.
- For motors equipped with case drains the case drain must be used to minimize the pressure acting on the hydraulic motor seal, and extend the life of the oil seal. The case drain line must be connected directly to the hydraulic reservoir with no restrictions, and the case drain port on the motor must always be oriented upward.

The case drain port on the hydraulic motor must never be plugged.











Control Systems

- All pump systems with electric or hydraulic power sources are required to have a control system which meets all local and national standards.
- For more detail on a typical system installation, see preceding subsections of the "Assembly and Installation" section of this manual.

Commissioning, Start-Up, Operation, Shutdown

Before attempting to start your pump, the following must be understood and followed to ensure safe operation.

Information

-  When running Hypro centrifugal pumps, it is essential that operators use hearing protection as the sound levels can reach levels of 80 decibels.
-  When handling Hypro pumps, one should wear steel-toed shoes and protective gloves in order to protect the feet in the event the pump is dropped and protect the hands from any sharp surfaces on the pump or chemicals.
-  Only authorized operators having the knowledge and skill necessary to safely use a Hypro pump, or any equipment the pump is connected to, may run the pump.
-  When spraying manually, it is recommended that chemical-resistant face masks and clothing be worn to prevent any chemicals from coming into contact with the skin or being inhaled.
-  When spraying manually, always spray downwind of yourself as long as the sprayed chemical will not drift into the vicinity of other people.
-  When installing, adjusting or removing a Hypro centrifugal pump, ensure that there are no objects which can fall on the installer and make certain that all machinery to which the pump is to be attached is turned off.
-  Hypro centrifugal pumps should only be used on tractors or tow-behind spray platforms which have electrically conductive tires in order to reduce the risk of electrocution.
-  Never operate a Hypro centrifugal pump outside while there is a chance of getting struck by lightning.
-  Never leave electrical wires or plumbing components where they can be a tripping hazard or become entangled in a moving component. Ideally, electrical cables, hoses, pipes and fittings should be routed overhead. In the event electrical wiring must be routed over the ground, operators are required to use rubber ramps if they cross a gangway.
-  Hypro centrifugal pumps should not be used if the ambient light is below 200lux.

 **Only use approved chemicals in your pump. For a complete list of approved chemicals, see the “Fluid Pumping Applications” section. Failure to follow this warning will void your warranty and could lead to property damage, serious injury or death.**

Start-up, Operation, Shutdown

Before Starting the Pump

- Ensure all unnecessary personnel are clear of the area.
- For initial setup and test of your system, it is recommended to start with clean water instead of chemicals, and confirm the system and plumbing connections are leak free.
- Ensure that there is fluid in the source tank or supply line. Do not run dry.
- Check line strainer for debris or clogs. Remove any found.
- Check all plumbing connections to make sure they are tight.
- Check power source and connections.
- Check that all valves and regulators are set to the desired setting and are functioning properly.
- Ensure all hoses are properly positioned and are not damaged in any way.
- Ensure PTO shaft shields are in place and are not loose.

Priming the Pump

To help prime the pump, keep the inlet or suction line as short as possible with a minimum of bends, elbows and kinks. Make sure all connections are tight and do not leak air. Non self-priming pumps must have the inlet line and pump flooded with liquid before starting the pump. For self-priming models, the front chamber should be filled with liquid before starting.

 **The pump must not be run dry.**

Starting, Operation and Shutdown of the Pump (Hydraulic)

Open Center Systems - All Models

Adjusting Centrifugal Pump Output

ATTENTION HM1C, HM3C & HM5C motors have bypass screw fully closed from the factory. HM2C & HM4C motors have bypass screw set at 1-1/2 turns from fully closed from the factory.

1. Open the bypass adjustment screw 2-1/2 turns from fully closed and secure it in place with the bypass jam nut.
2. Start the tractor. Leave the directional valve in the neutral position and allow hydraulic oil to circulate for approximately 10 to 15 minutes or until adequately warmed.
3. Prime the centrifugal pump with all valves open. (See Priming the Pump.)
4. Refer to sprayer manufacturer's manual to set spraying pressure and flow. To change the flow or pressure generated by the pump, turn the bypass screw on the hydraulic motor. Be sure to secure the bypass jam nut after any adjustment.
5. To shutdown, return directional valve to neutral and allow the pump to come to a gradual stop.

 When bypassing hydraulic oil, a large amount of heat can be generated which will damage the tractor's hydraulic system. Be sure to monitor the oil temp when bypassing hydraulic oil.

 If the pump is not brought to a gradual stop, the sudden change in hydraulic pressure and pump RPM could cause damage to the pump's drive system.

Closed Center (Pressure-Compensated) Systems

Adjusting Centrifugal Pump Output

1. Open the bypass adjusting screw in the hydraulic motor three (3) turns and secure it in place with the bypass jam nut.
2. Start the tractor and allow hydraulic oil to circulate for approximately 10 to 15 minutes or until adequately warmed
3. Close and lock down the bypass adjusting screw in the hydraulic motor.
4. Prime the centrifugal pump with all valves open. (See Priming the Pump.)
5. Refer to sprayer manufacturer's manual to set spraying pressure and flow. To change the flow or pressure generated by the pump, slowly adjust tractor's flow control valve.
6. To shutdown the pump, move the selector for the tractor spool valve to the float position and allow the pump to come to a gradual stop.

 If the pump is not brought to a gradual stop, the sudden change in hydraulic pressure and pump RPM could cause damage to the pump's drive system.

Closed Center (Load-Sensing) Systems





Adjusting Centrifugal Pump Output

1. Close and lock down the bypass adjusting screw, if equipped, in the hydraulic motor.
2. Set the tractor hydraulic flow control valve for minimum hydraulic oil flow to the remote outlet (Tortoise position).
3. Start the tractor and allow the hydraulic oil to circulate for approximately 10 to 15 minutes or until adequately warmed.
4. Prime the centrifugal pump with all valves open. (See Priming the Pump.)
5. Refer to sprayer manufacturer's manual to set spraying pressure and flow. To change the flow or pressure generated by the pump, slowly adjust tractor's flow control valve.
6. To shutdown the pump, move the selector for the tractor spool valve to the float position and allow the pump to come to a gradual stop.

 If the pump is not brought to a gradual stop, the sudden change in hydraulic pressure and pump RPM could cause damage to the pump's drive system.

Maintenance and Servicing

Information

-  All maintenance should be done when machinery is stationary and has been isolated from its energy sources. It is dangerous to perform maintenance while machinery is still connected to its power source. Machinery should be isolated from its electrical, hydraulic or gas engine power source.
-  Be sure to release all pressure from the system before performing any sort of maintenance on a Hypro pump.
-  DO NOT perform service or maintenance to the pump, or attached components, until the pump unit is below 109°F(43°C).
- The lubrication of this pump unit has been done at the factory prior to shipping.
-  When handling Hypro pumps, one should wear steel-toed shoes and protective gloves in order to protect the feet in the event the pump is dropped and protect the hands from any sharp surfaces on the pump or chemicals. If the pump is being repaired while the pump is in service, eye protection should also be worn.

Any hazardous liquids should be disposed of in a manner which complies with local and national regulations. Never dump fluids onto the ground.

Disposal

When disposing of a Hypro pump, be sure to remove all fluids from the pump before scrapping. These fluids should be disposed of in a manner which complies with local and national regulations. Never dump fluids onto the ground. Once the pump is free of all fluids, it may be scrapped in accordance with local and national laws.

Cleaning

Your pump will last longer and give best performance when properly taken care of. Proper pump care depends on the liquid being pumped and when the pump will be used again. After each use, flush pump with a neutralizing solution for the liquid just pumped. Follow with a clean water rinse. This is especially important for corrosive chemicals. It is good practice to clean the pump after each use to prevent deposits from forming and damaging the pump. For infrequent use and before long periods of storage, drain pump thoroughly. Open any drain plugs, remove suction hose from liquid, and blow pump dry with air. An antifreeze/rust inhibitor should be injected into the pump before both ports are plugged and the pump is stored. Plug all ports to keep out air until pump is used again.

Maintenance, Routine Servicing, and Inspection

PREVENTATIVE MAINTENANCE CHECKLIST

Check	Daily	Weekly
Water Leaks	X	
Plumbing		X
Filters	X	

- Each system's maintenance cycle will be exclusive. If system performance decreases, check immediately.
- Duty cycle, temperature, quality, type of fluid being pumped, and inlet feed conditions all affect the life of spray boom assemblies and service cycle.
-  Before attempting to service your pump, be sure that it is disconnected from all energy sources.

Troubleshooting

Before attempting to service your pump, be sure that it is disconnected from all energy sources.

Symptom	Probable Cause(s)	Corrective Action
<i>Pump does not prime</i>	Leak in suction line	Check hose and fittings for leaks and correct
	Obstruction in suction line	Inspect hose for obstructions and remove
	Suction hose stuck to tank	Cut a notch or "V" in end of suction hose
	Clogged Strainer	Check strainer and clean regularly
<i>Low Discharge</i>	Pump rotates incorrectly	Hydraulic hoses hooked up incorrectly
	Blocked suction hose	Inspect suction line and strainer, and repair as necessary
	Pump worn	Repair pump
	Undersized suction line or collapsed hose	Suction line should be the same diameter as inlet port of pump or larger
	Pump not primed	Remove topmost vent plug from face of pump and run pump to expel trapped air (See Installation Instructions)
	Leak in suction line	Check hose and fittings for leaks and correct
	Hydraulic bypass needs adjustment	See Startup, Operation, Shutdown
	Impeller plugged	Inspect and clear obstruction
<i>Pump will not turn</i>	Hydraulic hoses hooked up incorrectly	See Installation Instructions
	Motor seized/contamination	Repair or replace hydraulic motor
<i>Hydraulic system overheating</i>	Hydraulic bypass needs adjustment	See Installation Instructions
	Insufficient hydraulic hose size	See Installation Instructions

Table 2

Replacement Parts

The following drawings show the pumps and their replacement parts. **Only genuine replacement parts should be used. Failure to follow this warning can result in damage to property, serious injury or death.** If the pump malfunctions or is defective, it should be sent back to Hypro for service.

9306C(S)-HM1, 3, 5C and 9306C(S)-HM1, 3, 5C-3U

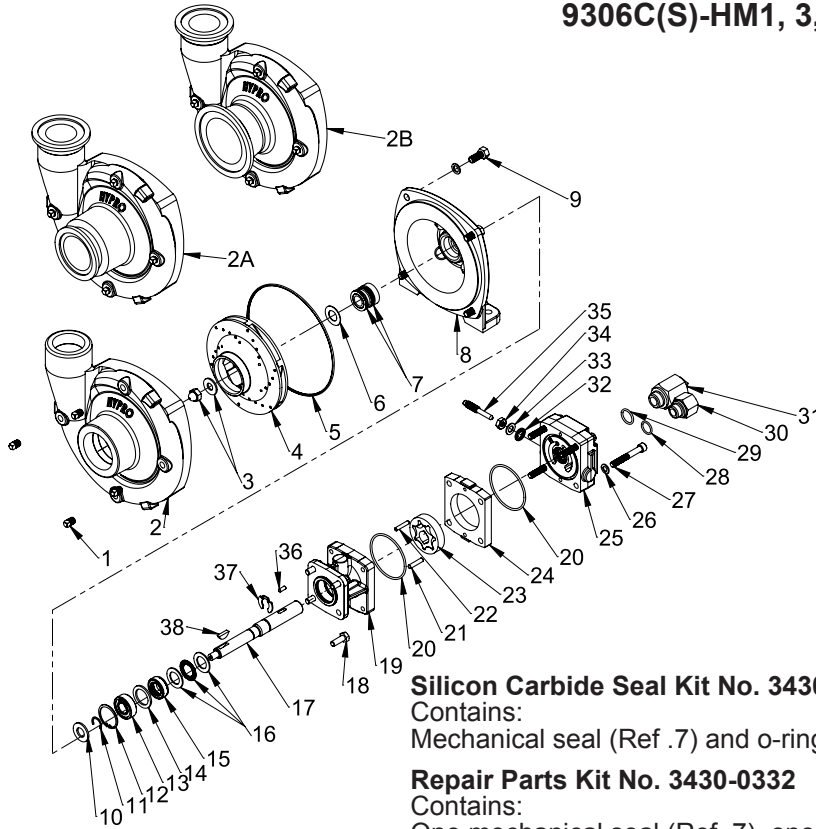

NOTE: When ordering parts, give QUANTITY, PART NUMBER, DESCRIPTION, and COMPLETE MODEL NUMBER. Reference numbers are used ONLY to identify part in the drawing and are NOT to be used as order numbers.

Parts Kit No. 3430-0881
 Contains: One each ball bearing (Ref. 13), motor shaft seal (Ref. 15), thread seal gasket (Ref. 32), and washer (Ref. 33); two spacer O-rings (Ref. 20), and port adapter o-rings (Ref. 28 & 29).

Silicon Carbide Seal Kit No. 3430-0589
 Contains:
 Mechanical seal (Ref. 7) and o-ring (Ref. 5).

Repair Parts Kit No. 3430-0332
 Contains:
 One mechanical seal (Ref. 7), one o-ring (Ref. 5) and one rubber gasket (Ref. 6).

Hydraulic Motor Part Nos.
 2540-0806C (HM1C Models)
 2540-1606C (HM3C Models)
 2540-1006C (HM5C Models)

Ref. No.	Qty. Req'd.	Part No.	Description
1	4	2406-0016	Drain/Vent Plug
2	1	0154-9200C1	Pump Casing (9306C)
2	1	0154-9200S1	Pump Casing (9306S)
2A	1	0157-9200C	Pump Casing (Universal Flange 2" X 2" Cast)
2A	1	0157-9200S	Pump Casing (Universal Flange 2" X 2" S.S)
2B	1	0158-9200C	Pump Casing (Universal Flange 3" X 2" Cast)
2B	1	0158-9200S	Pump Casing (Universal Flange 3" X 2" S.S.)
3	1	3430-0825	Impeller Nut (9306C and 9306S)
4	1	0401-9200P2	Impeller (Nylon Std. 9306C)
4	1	0405-9100P2	Impeller (Polypropylene Optional) (Std. 9306S)
4	1	0407-9306P	Impeller (GTX Optional)
5	1	3430-0332	O-ring
6	1	3430-0332	Gasket
7	1	3430-0332	Mechanical Seal (Viton/Cermaic) (Std. 9306C)
7	1	3430-0589	Mechanical Seal (Silicon Carbide) (Std. 9306S)
8	1	0750-9300C2	Mounting Flange (9306C)
8	1	0756-9300S	Mounting Flange (9306S)
9	4	2210-0020	Hex Head Cap Screw (9306C)
9	4	2210-0125	Hex Head Cap Screw (9306S)
10	1	1410-0056	Slinger Ring
11	1	1810-0014	Snap Ring
12	1	1820-0013	Retaining Ring
13	1	3430-0881	Ball Bearing
14	1	1410-0154	Spacer
15	1	3430-0881	Lip Seal
16	1	2029-0014	Thrust Bearing Assembly
17	1	3430-0852	Shaft (HM1C/HM5C)
17	1	3430-0855	Shaft (HM3C)
18	4	2210-0005	Hex Head Cap Screw
19	1	0150-2540C	Motor Body (Includes needle bearing)
19	1	0150-2542C	Motor Body Case Drain SAE -4 (Includes needle bearing)

Ref. No.	Qty. Req'd.	Part No.	Description
20	1	3430-0881	O-ring
21	1	1600-0095	Dowel Pin (HM1C/HM5C)
21	1	1600-0096	Dowel Pin (HM3C)
22	1	1600-0084	Dowel Pin (HM1C/HM5C)
22	1	1600-0085	Dowel Pin (HM3C)
23	1	3900-0022	Gerotor (HM1C)
23	1	3900-0024	Gerotor (HM3C)
23	1	3900-0048	Gerotor (HM5C)
24	1	0720-2603	Gerotor Housing (HM1C Models) 1/2" wide
24	1	0720-2606	Gerotor Housing (HM3C Models) 1" wide
24	1	0720-2604	Gerotor Housing (HM5C Models) 5/8" wide
25	1	0254-2500C2	Motor End Plate (includes needle bearing)
25	1	0254-2500C3	Motor End Plate -8, -10 SAE, No Bypass (Includes needle bearing)
26	4	2270-0039	Washer
27	4	2220-0021	Cap Screw (HM1C Models)
27	4	2220-0044	Cap Screw (HM3C Models)
27	4	2220-0032	Cap Screw (HM5C Models)
28	1	3430-0881	O-ring
29	1	3430-0881	O-ring
30	1	3360-0021A	Pressure Port Adapter (includes o-ring)
31	1	3320-0051A	Tank Port Adapter (includes o-ring)
32	1	3430-0881	Gasket
33	1	3430-0881	Washer
34	1	2250-0038	Lock Nut
35	1	3220-0029	Bypass Adjusting Screw
36	1	1610-0031	Gerotor Key (HM1C/HM5C)
36	1	1610-0055	Gerotor Key (HM3C)
37	1	1810-0026	Snap Ring
38	1	1610-0012	Woodruff Key (9306C)
38	1	04432-SHW	Woodruff Key (9306S)

EC DECLARATION OF INCORPORATION

EC Declaration of Incorporation

Manufacturers Name: Pentair Flow Technologies, LLC
 Manufacturers' Address: 375 Fifth Avenue NW,
 New Brighton, MN 55112, USA

Declare that the partially complete machinery described below conforms to applicable health and safety requirements of Emission Directive 2010/26/EU and of Parts 1 of Annex I of Machinery Directive 2006/42/EC. This partly completed machinery must not be put into service until the equipment into which it is to be incorporated has been declared in conformity with the provisions of these directives. Confidential technical documentation has been compiled as described in Annex VII Part B of Machinery Directive 2006/42/EC and is available to European national authorities on written request. If a request is received, documentation will be transmitted either electronically or by post. Clauses 1.1.4, 1.1.7, 1.1.8 Section 1.2, Clauses 1.3.5, 1.3.6, 1.3.7, 1.3.8.1, 1.3.8.2, 1.3.9, 1.4.1, 1.4.2.1, 1.4.2.2, 1.4.2.3, 1.4.3, 1.5.2, 1.5.7, 1.5.12, 1.5.14, 1.5.16, 1.6.2, 1.7.1.1, 1.7.1.2, 1.7.2, and 1.7.4.2 are clauses of Machinery Directive 2006/42/EC that have not been met, but could be applicable and must be addressed during installation by a third party.

Description: PENTAIR Pump

Type: Roller Pumps
 Series Numbers: 1502, 1700, 4001, 4101, 6500, 7560, 7700

Type: Centrifugal Pumps
 Series Numbers: 1442P, 1539, 1540, 1542P, 1543P, 1550, 90XX, 9202, 9203, 9205, 9206, 9208, 9262, 9263, 9253, 9302, 9303, 9305, 9306, 9307, 9308, 9313, 9314, 9316, 9342P, 9343P, 9742P, 15HPS, 93HPS

Type: Cleanload Assembly
 Series Numbers: 3376, 3378

Type: Piston/Plunger Pumps
 Series Numbers: 5315C, 5320C, 5321C, 5322C, 5324C, 5325C, 5330C, 53702, 53703

The following standards have either been referred to or been complied with in part or in full as relevant:

ENISO 12100	Machinery Safety	-	General principles for design - Risk assessment and risk reduction
EN809-1998 + A1 2009	Machinery Safety	-	Pumps and pump units for liquids - Common safety requirements
EN ISO 13732-1	Machinery Safety	-	Ergonomics of the thermal environment
EN ISO 3744:2010	Acoustics	-	Determination of sound power levels and sound energy levels of noise sources using sound pressure
EN ISO 11202/A1 1997	Machinery Safety	-	Noise emitted by machinery and equipment
EN 12162:2001+A1:2009	Machinery Safety	-	Liquid pumps - Safety requirements-Procedure for hydrostatic testing
EN ISO 4254-6:2009	Machinery Safety	-	Sprayers and liquid fertilizer distributors
EN 60204-1:2006/A1:2009	Machinery Safety	-	Electrical Equipment of Machines

Name Position.....

Signature Date.....

Place of Signing.....

EC **REP**
QNET BV
Hommerterweg 286
6436 AM Amstenrade
The Netherlands

Rev 12/22/18

LIMITED WARRANTY ON HYPRO/SHURFLO AGRICULTURAL PUMPS & ACCESSORIES

Hypro/Shurflo (hereafter, "Hypro") agricultural products are warranted to be free of defects in material and workmanship under normal use for the time periods listed below, with proof of purchase.

- Pumps: one (1) year from the date of manufacture, or one (1) year of use. This limited warranty will not exceed two (2) years, in any event.
- Accessories: ninety (90) days of use.

This limited warranty will not apply to products that were improperly installed, misapplied, damaged, altered, or incompatible with fluids or components not manufactured by Hypro. All warranty considerations are governed by Hypro's written return policy.

Hypro's obligation under this limited warranty policy is limited to the repair or replacement of the product. All returns will be tested per Hypro's factory criteria. Products found not defective (under the terms of this limited warranty) are subject to charges paid by the returnee for the testing and packaging of "tested good" non-warranty returns.

No credit or labor allowances will be given for products returned as defective. Warranty replacement will be shipped on a freight allowed basis. Hypro reserves the right to choose the method of transportation.

This limited warranty is in lieu of all other warranties, expressed or implied, and no other person is authorized to give any other warranty or assume obligation or liability on Hypro's behalf. Hypro shall not be liable for any labor, damage or other expense, nor shall Hypro be liable for any indirect, incidental or consequential damages of any kind incurred by the reason of the use or sale of any defective product.

RETURN PROCEDURES

All products must be flushed of any chemical (ref. OSHA section 1910.1200 (d)(e)(f)(g)(h)) and hazardous chemicals must be labeled/tagged before being shipped¹ to Hypro for service or warranty consideration. Hypro reserves the right to request a Material Safety Data Sheet from the returnee for any pump/product it deems necessary. Hypro reserves the right to "disposition as scrap" products returned which contain unknown fluids. Hypro reserves the right to charge the returnee for any and all costs incurred for chemical testing, and proper disposal of components containing unknown fluids. Hypro requests this in order to protect the environment and personnel from the hazards of handling unknown fluids.

Be prepared to give Hypro full details of the problem, including the model number, date of purchase, and from whom you purchased your product. Hypro may request additional information, and may require a sketch to illustrate the problem.

Contact the appropriate Hypro Service Department to receive a Return Merchandise Authorization number (RMA#).

Returns are to be shipped with the RMA number clearly marked on the outside of the package. Hypro shall not be liable for freight damage incurred during shipping. Please package all returns carefully. All products returned for warranty work should be sent shipping charges prepaid:



AMERICAS & ALL OTHER REGIONS

Hypro / Pentair
Attention: Service Department
375 Fifth Avenue NW
New Brighton, MN 55112
Service: 800-468-3428
Fax: 651-766-6618
Technical: 800-445-8360
hypro.technicalpentair.com

CANADA

Pentair Water Belgium B.V.B.A
Industriepark Wolfstee
Toekomstlaan 30, 2200
Herentals, Belgium
Tel: +32 14 259 911
Fax: +32 14 259 975
shurflo.service@pentair.com

CENTRAL & SOUTH AMERICA

+55 (11) 3317-5085
vendas.pwdb@pentair.com

pentair.com

¹ Carriers, including U.S.P.S., airlines, UPS, ground freight, etc., require specific identification of any hazardous material being shipped. Failure to do so may result in a substantial fine and/or prison term. Check with your shipping company for specific instructions.

For a detailed list of where Pentair trademarks are registered, please visit www.pentair.com/en/registrations.html. Pentair trademarks and logos are owned by Pentair PLC or its affiliates. Third party registered and unregistered trademarks and logos are the property of their respective owners. Because we are continuously improving our products and services, Pentair reserves the right to change specifications without prior notice. Pentair is an equal opportunity employer.